

Fixed Bath Screen

INSTALLATION INSTRUCTIONS

www.aquadart.co.uk

Item Number: AQ9352S

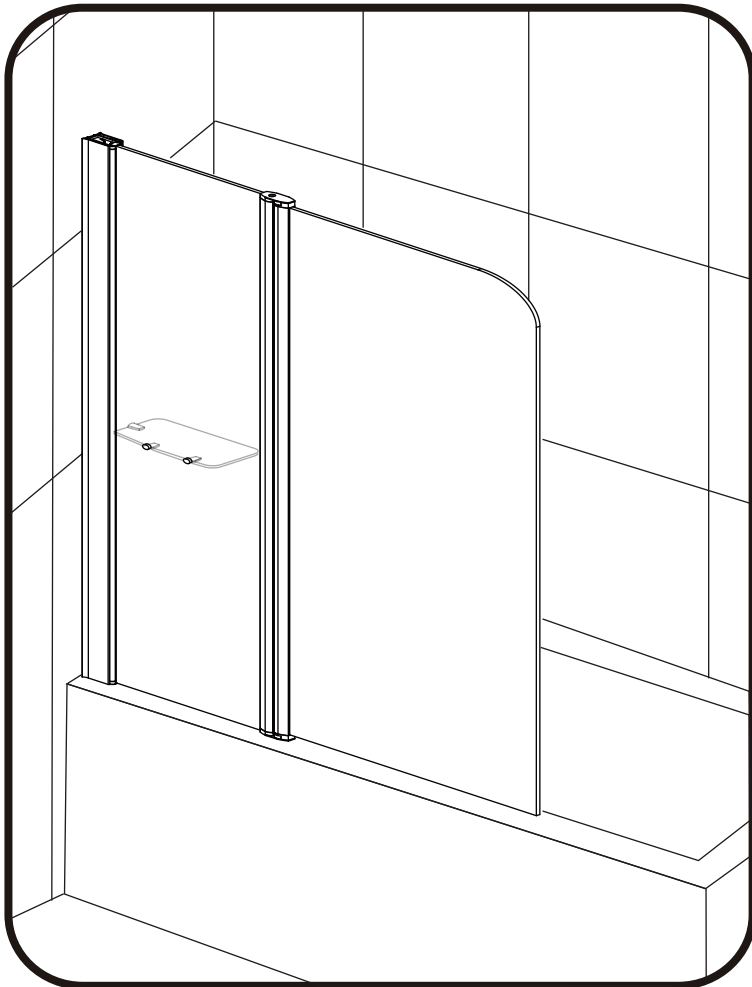

Lifetime Product Guarantee

To activate your Product Guarantee please visit www.aquadart.co.uk and complete the online form.

Tools Required



Drill

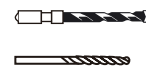

6mm Masonry Drill
2.75mm HSS Drill



Tape Measure



Spirit level



PH2 TYPE
Screwdriver



Pencil



Sealant Gun

Please note hand tools **NOT** supplied.

IMPORTANT

This product should be installed by a suitably qualified and proficient person. The fitting instructions should be followed carefully to ensure a proper and safe installation. Failure to follow these instructions could result in future injury.

These instructions and list of parts assume that installation is done against solid/tiled walls.

Please check this product for damage prior to starting the installation. No claims can be made after the product has been fitted.

PLEASE NOTE :The minimum and maximum adjustment sizes noted on the product brochures are based on perfectly plumb walls and trays.

USE SAFETY EYE-WEAR WHEN DRILLING

COMPONENTS AND BOX CONTENTS

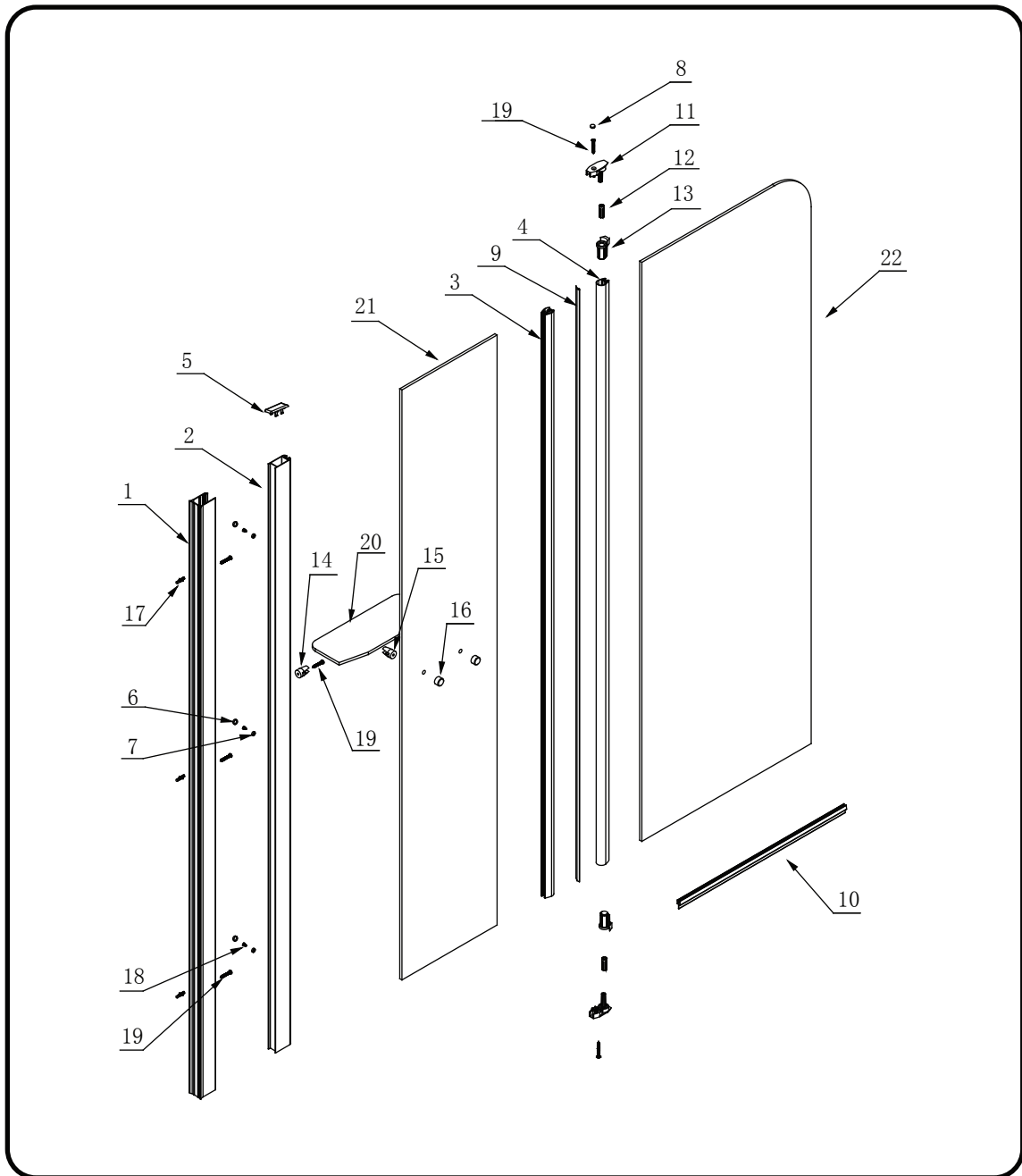

Box Contents

SN	Description	Qty	SN	Description	Qty
1	Wall Profile	1	13	Pivot Part 3	2
2	Upright Profile	1	14	Glass Clip A	1
3	Connected Profile	1	15	Glass Clip B	2
4	Frame Profile	1	16	Glass Clip Cover	2
5	Profile Top Cap	1	17	Wall Plug	4
6	Screw Cover Cap	3	18	Screw ST3.5x10	3
7	Cap	3	19	Screw ST4x30	6
8	Cover Cap	1	20	Glass Shelf	1
9	Upright Seal	1	21	Fixed Glass Panel	1
10	Bottom Seal	1	22	Moving Glass Panel	1
11	Pivot Part 1	2			
12	Pivot Part 2	2			

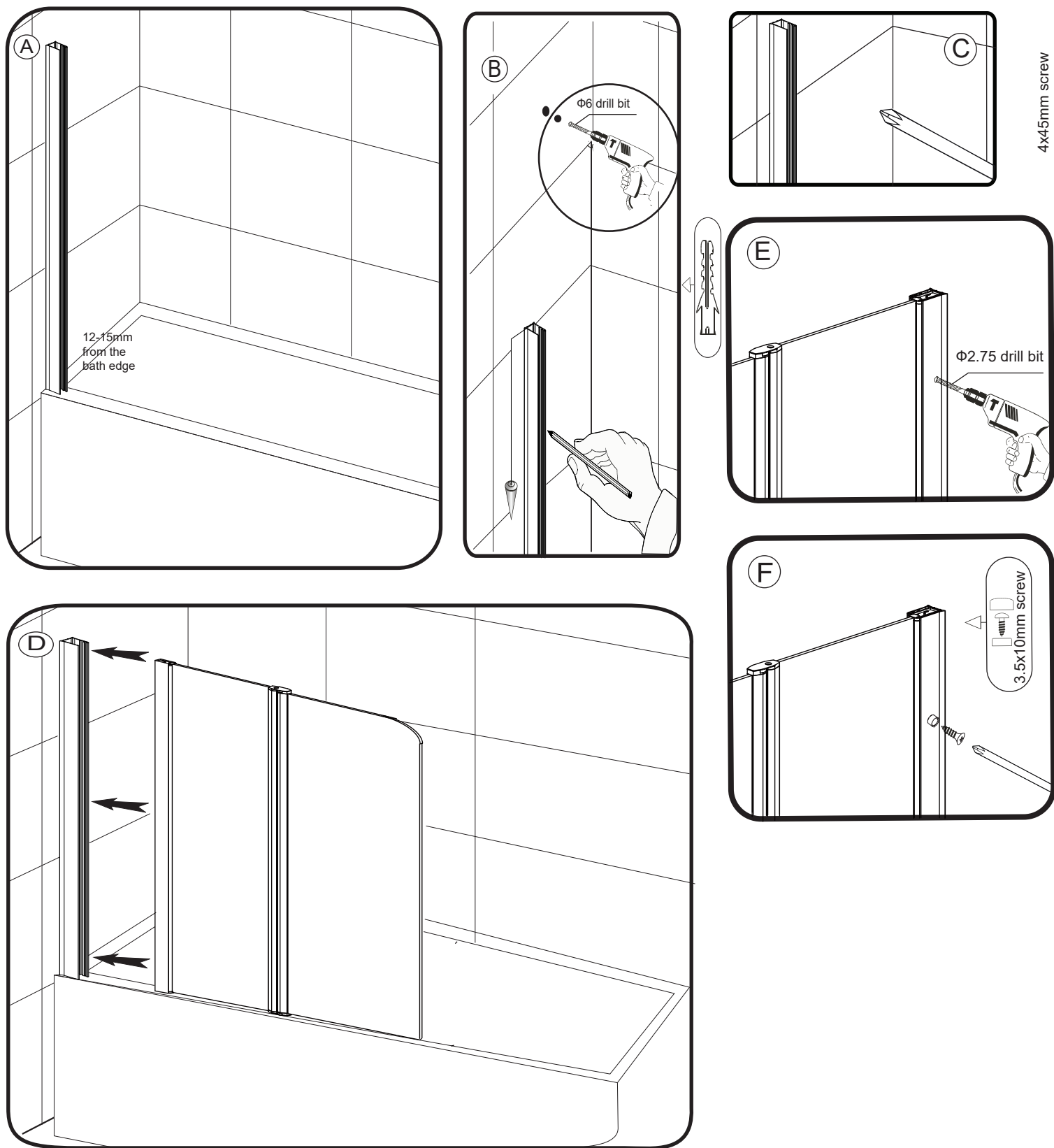

Step 1: Position the wall profile (1) onto the bath , approximately 12-15mm from the outside bath edge to ensure that the screen runs along the inside edge of the bath rim. (A).

Step 2: Level the profile with a spirit level , then mark the position using a pencil. Mark through the 3 pre-drilled screw holes in the wall profile. (B).

NOTE : You may find it easier to mark and drill the wall if you apply masking tape to it first.

Step 3: Drill the marked points using a 6mm masonry drill bit.

Step 4: Insert 3 wall plugs (18) into the wall holes , then secure the wall profile using 3 x ST4X45 screws (21). (C)

Step 5 : Carefully position the screen into the wall profile. (D)

Step 6 : Secure to the wall profile using 3 x ST3.5X10 screws (21) and cover caps (6) and (7). (E) (F)

Assemble The Glass Shelf

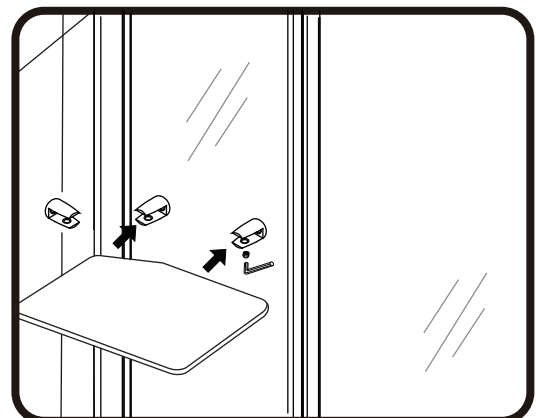
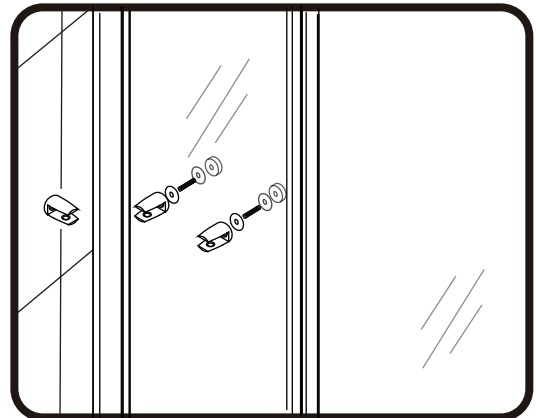
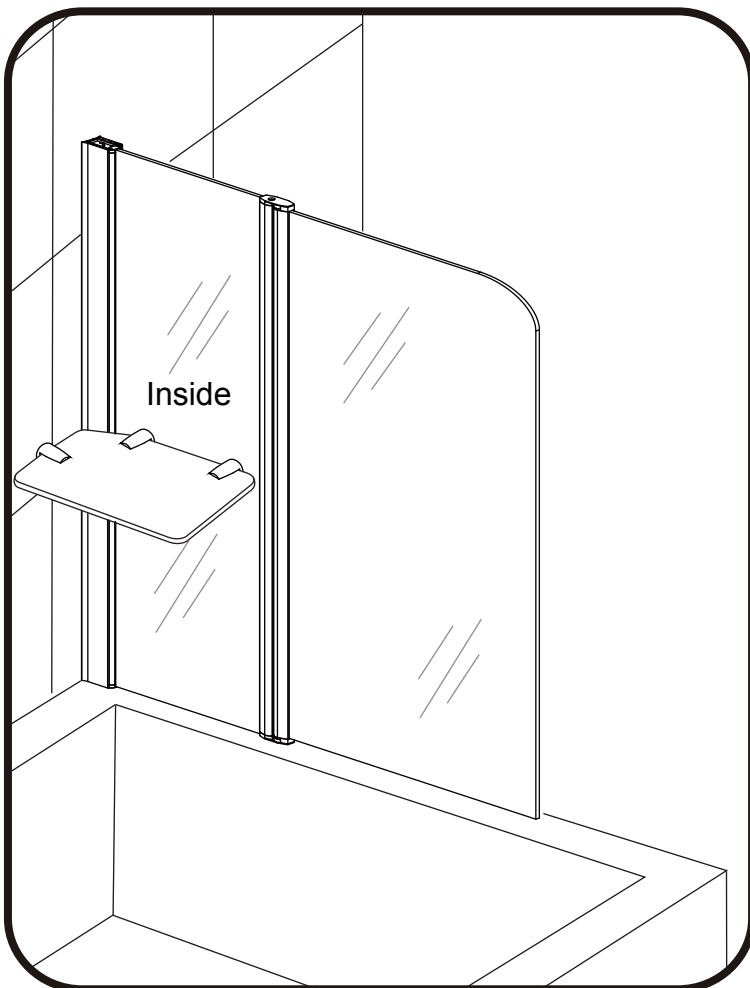
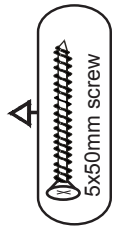
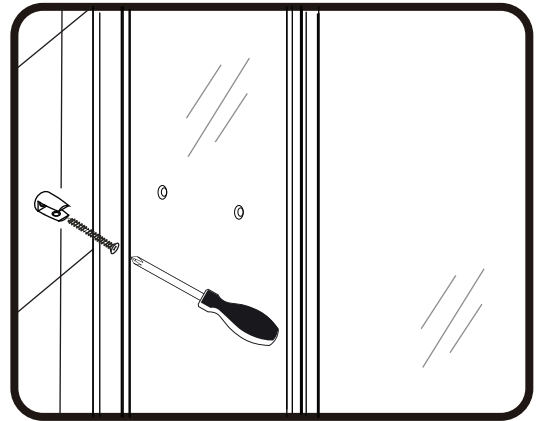
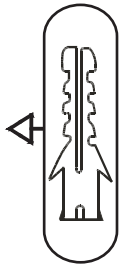
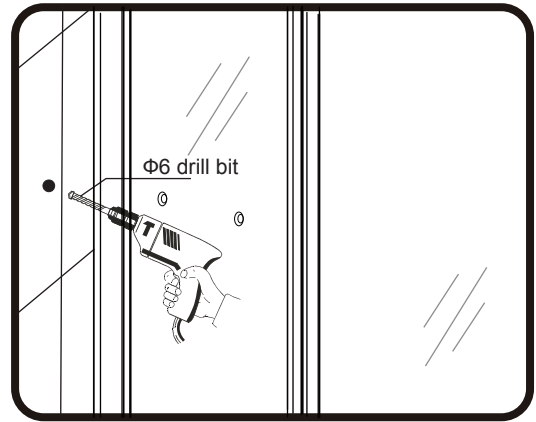
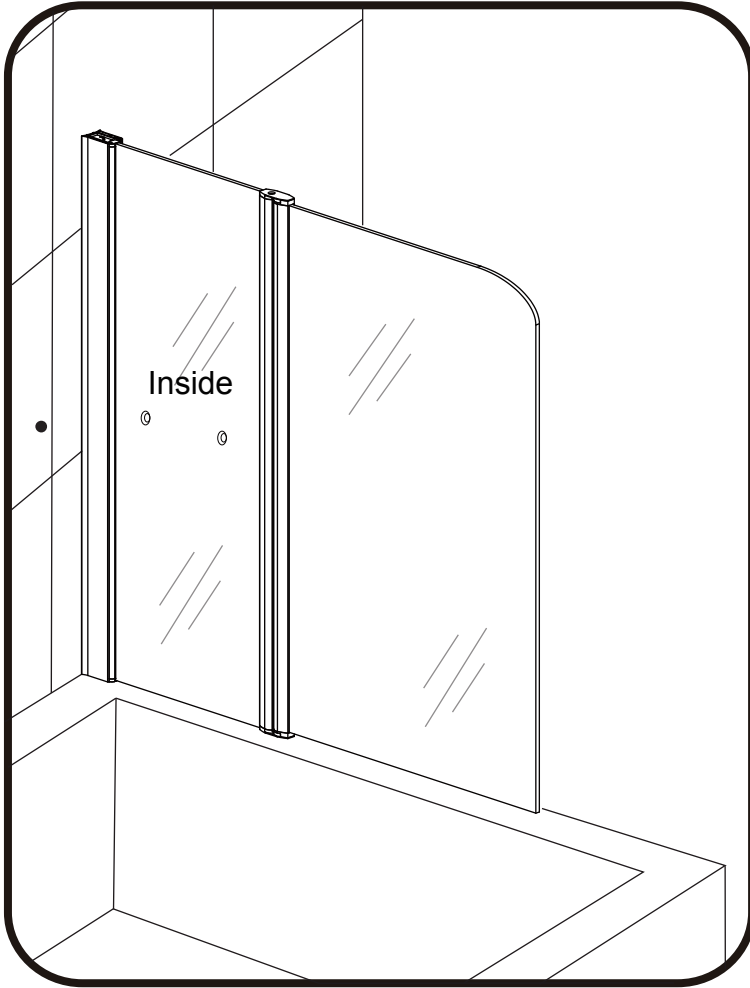

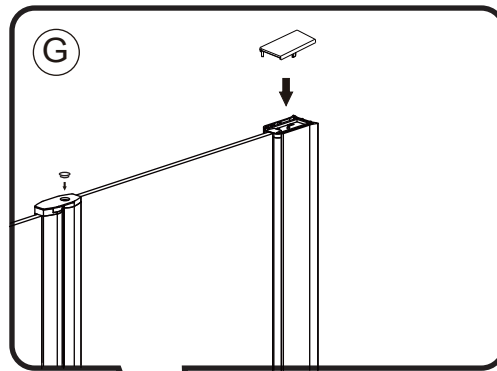

Silicone the outside of the vertical wall post and also the outside of the bottom of the wall post as shown.

Allow 24 hours before use for silicone to set.

For cleaning instructions see guarantee.

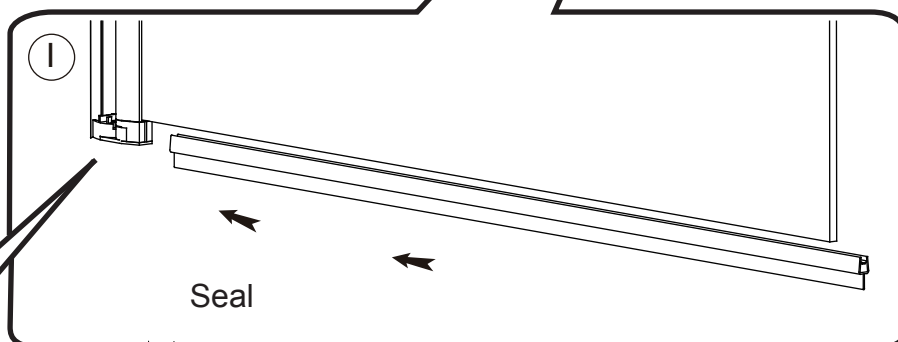
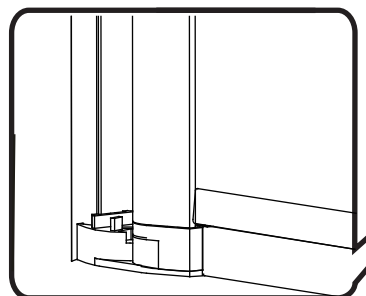
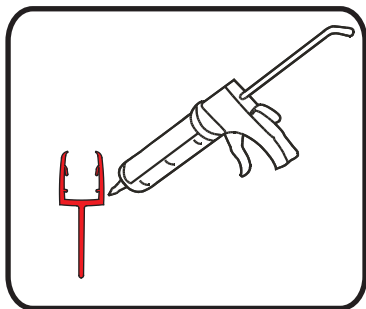
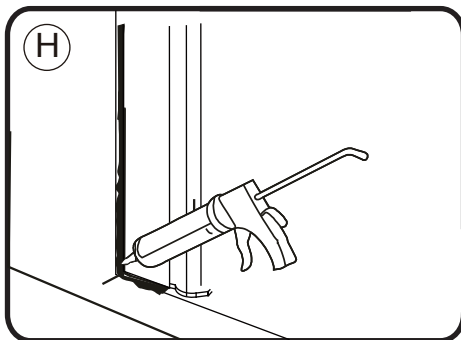

NOTE : To ensure a watertight seal ensure the bottom seal (No.10) is fully inserted into the base of the hinge as per the above diagram.

AFTERCARE

Cleaning Instructions

It is important to clean your Aquadart shower enclosure after every use. Please wipe down all glass and metal parts with a clean soft cloth. Ensure that all residual water on the glass is removed after every use.

Usage

For reliable, watertight performance from your Aquadart enclosure your shower head should not be positioned so that the shower sprays directly onto the enclosure door. Failure to comply with this may cause the shower to leak. Outward opening doors may cause water to drip onto the floor, please ensure that the floor covering immediately outside the enclosure will not be affected by water.

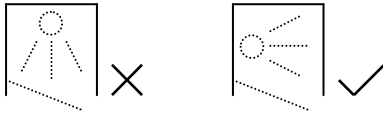

This product has been treated with Clean & Clear™ easy clean glass treatment, a protective barrier which creates a 'non-stick' surface on your glass, helping to resist lime scale build up and water spots. For further information on Clean & Clear™ please visit www.aquadart.co.uk

Aftercare

Clean & Clear™ glass can be cleaned with any suitable nonabrasive glass cleaner - with PH value of between 3-11; the coating will not be damaged. Avoid surfactants and heavily perfumed products. Vinegar and water based products are very effective. Do not use abrasive scrubbing cleaners or equipment for cleaning.

Warranty

Limited 5 year Warranty for Clean & Clear™ treatment: To guarantee treated surfaces will remain more repellent than untreated glass for 5 years from start of use, as long as basic manufacturer maintenance recommendations are followed and no harsh or abrasive cleaners are used.

AQUADART

Riverside Business Park, Royd Ings Avenue, Keighley, West Yorkshire, BD21 4AF
For technical / aftersales queries, please visit our website : www.aquadart.co.uk
or Sales Tel : 01535 613830 Technical: 01535 613830 Fax: 01535 613831

